

FOX

40

TUNING GUIDE



SAG SETTING

To achieve the best performance from your FOX suspension, adjust the air pressure to attain your proper sag setting. Sag is the amount your suspension compresses under your weight and riding gear. Sag range should be set to 15–20% of total fork travel.

Make sure to set sag with the LSC adjuster in the full counter-clockwise (OPEN) position, see page 5-6.

Watch the sag setup video at ridefox.com/sagsetup

Suggested Sag Measurements		
Travel	15% sag (Firm)	20% sag (Plush)
203 mm (8 in)	30 mm (1.2 in)	41 mm (1.6 in)

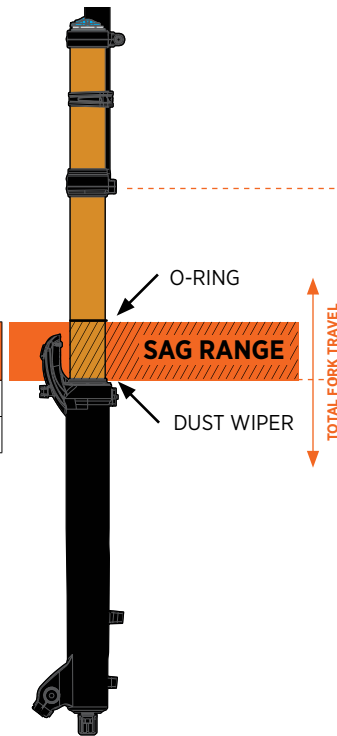

Your fork has a 4 digit ID code on the back of the lower leg. Use this number on the Help page at www.ridefox.com to find out more information about your fork.



The recommended settings in this tuning guide are designed to be a **starting point**, in order to get you out on your first ride in as few steps as possible. Consult your bike manufacturer's instructions for setup recommendations.

As you ride and get used to your new fork, adjust your settings as needed. Detailed information and videos can be found in the online owner's manual.

Suggested Starting Points for Setting Sag		
Rider Weight (lbs)	Rider Weight (kgs)	FLOAT Pressure (psi)
120-130	54-59	49
130-140	59-64	53
140-150	64-68	57
150-160	68-73	61
160-170	73-77	65
170-180	77-82	69
180-190	82-86	73
190-200	86-91	76
200-210	91-95	80
210-220	95-100	84
220-230	100-104	88
230-240	104-109	92
240-250	109-113	96



Do not exceed maximum air pressure:

40 FLOAT maximum air pressure is **120 psi**.

REBOUND ADJUSTMENT

The rebound adjustment is dependent on the air pressure setting. For example, higher air pressures require lower rebound settings. Use your air pressure to find your rebound setting.

Turn your rebound knob to the closed position (full clockwise) until it stops. Then back it out (counter-clockwise) to the number of clicks shown in the table below.

REBOUND

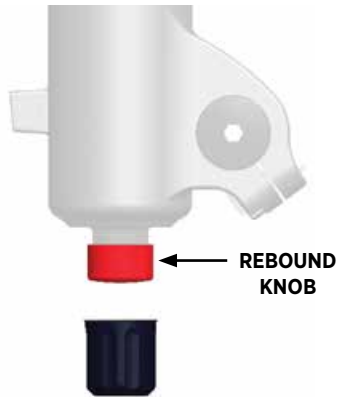

Rebound controls the rate of speed at which the fork extends after compressing.

FLOAT Pressure (psi)	Recommended Rebound Setting RC2
49	13
53	12
57	11
61	10
65	9
69	8
73	7
76	6
80	5
84	4
88	3
92	2
96	1

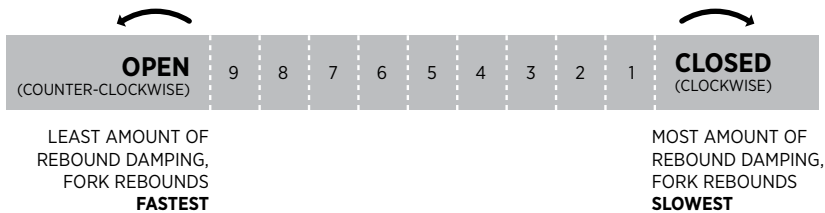

FACTORY SERIES HSC/LSC COMPRESSION ADJUSTERS

Use this diagram as a starting point for your compression adjusters.

Turn your compression adjusters to the closed position (full clockwise) until they stop. Then back them out (counter-clockwise) to the number of clicks shown below.



High-speed compression adjustment is useful to control fork performance during bigger hits, landings, and square-edged bumps.

Low-speed compression adjustment is useful to control fork performance during rider weight shifts, G-outs, and other slow inputs.

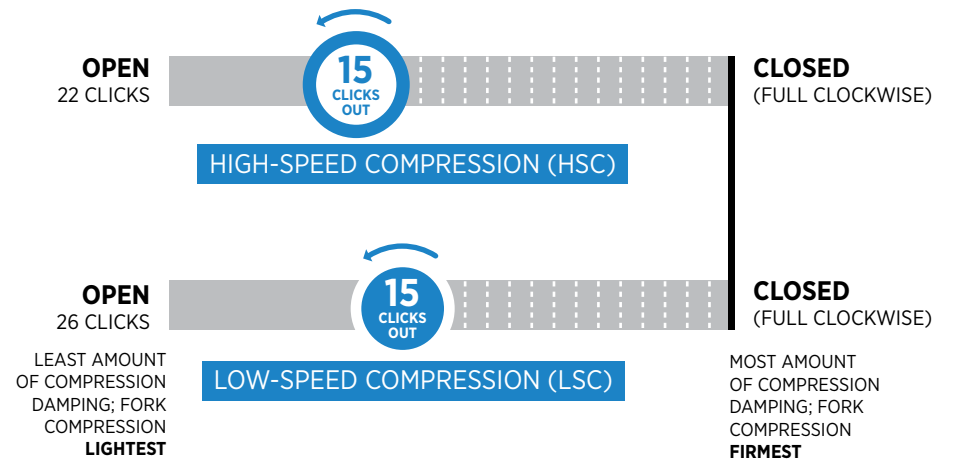

PERFORMANCE ELITE LSC COMPRESSION ADJUSTER

Use this diagram as a starting point for your compression adjuster.

Turn your compression adjuster to the closed position (full clockwise) until it stop. Then back it out (counter-clockwise) to the number of clicks shown below.



Low-speed compression adjustment is useful to control fork performance during rider weight shifts, G-outs, and other slow inputs.

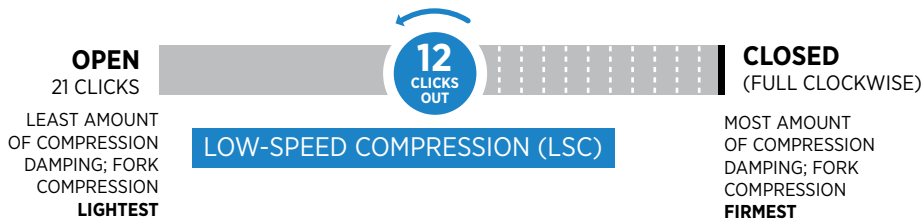

INSTALL THE FRONT WHEEL

1. Install the front wheel into the dropouts and slide the axle through the dropouts and hub.
2. Using a 5mm hex wrench, torque the axle to 2.15 Nm (19 in-lb).
3. Torque the two pinch bolts on the rider's left dropout to 2.15 Nm (19 in-lb).
4. Compress the fork a couple of times to let the right side of the dropout float and settle to its low-friction point.
5. Torque the two pinch bolts on the rider's right dropout to 2.15 Nm (19 in-lb).

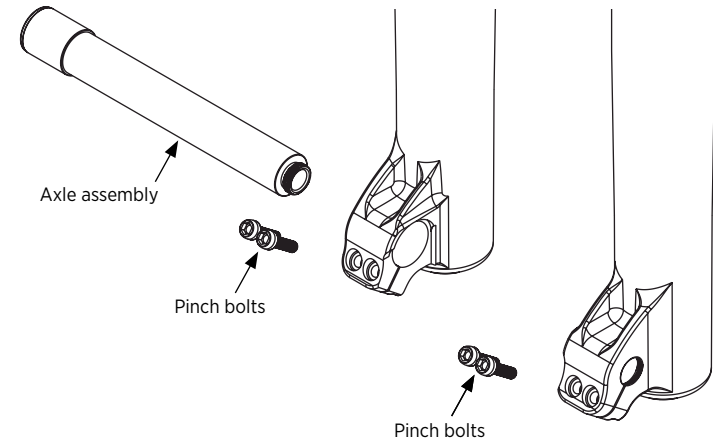

WARNING: Failure to secure the axle properly can cause the wheel to become detached from the bicycle, resulting in SERIOUS INJURY OR DEATH.

ADDITIONAL TUNING OPTIONS

CLIP-ON VOLUME SPACERS

Changing volume spacers in the 40 FLOAT fork is an easy internal adjustment that allows you to change the amount of mid stroke and bottom out resistance.

If you have set your sag correctly and are using full travel (bottoming out) too easily, then you could install one or more spacers to increase bottom out resistance.

If you have set your sag correctly and are not using full travel, then you could remove one or more spacers to decrease bottom out resistance.

Installation procedure and tuning options are available online at: ridefox.com/ownersmanuals

40 FLOAT Volume Spacer Configurations	
Volume Spacers Factory Installed	*Max Volume Spacers
4	7



*Do not exceed the Max Volume Spacers number, as this can damage your fork.

TYPICAL AIR SPRING CURVES

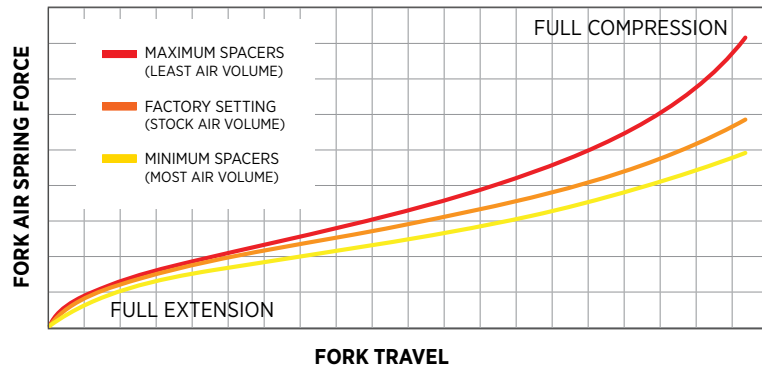

SEE ADDITIONAL INFORMATION AND VIDEOS:

40 FLOAT ridefox.com/40setup



©FOX FACTORY, INC. 2016 // 1.800.FOX.SHOX
915 Disc Drive · Scotts Valley, CA 95066 USA
TEL 831.768.1100

605-00-163 REV A

